

MODEL DESIGNATION

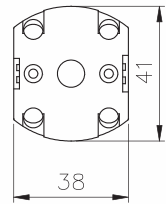

Designation	Signal	Description	Designation	Signal	Description
1. Control type	AS33	AS33 (3Ø3W)	2. Size	4	48 * 48
	AS34	AS34 (3Ø4W)		6	64 * 64
	VS33	VS33 (3Ø3W)	3. Capacity	1	10A
	VS34	VS34 (3Ø4W)		2	16A
	VS334	VS33 (3Ø3W)/VS34 (3Ø4W)		3	25A
	AV33	VS33 (3Ø3W)/AS33 (3Ø3W)	4. Nos.of	None	2CT
		3		3CT	

DIMENSIONS

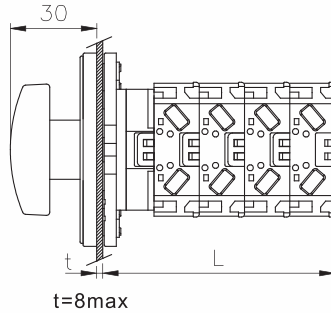
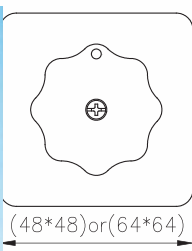

Stack	L
One stack	32
Two stacks	47
Three stacks	62
Four stacks	77
Five stacks	92
Six stacks	107

PLATE, CONTACT AND WIRING DIAGRAM

TAS33-□□
AS(3Ø3W 2CT)

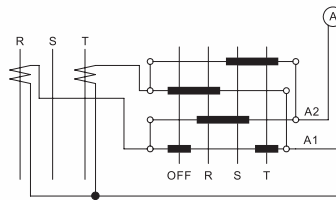
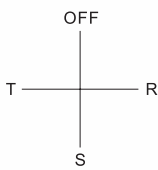

TVS33-□□
VS(3Ø3W)

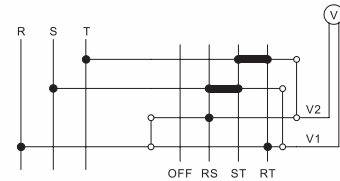
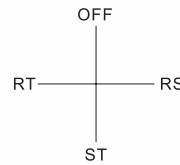

TAS33-□□3
AS(3Ø3W 3CT)

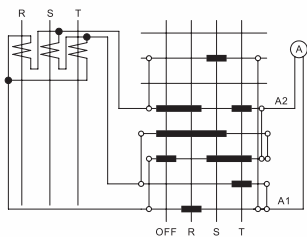
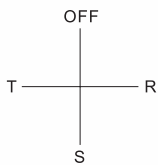

TVS34-□□
VS(3Ø4W)

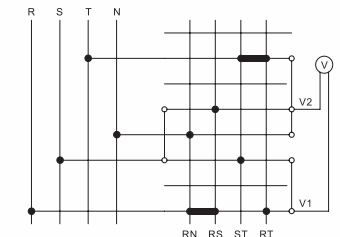
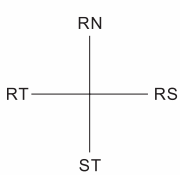

TAS34-□□3
AS(3Ø4W 3CT)

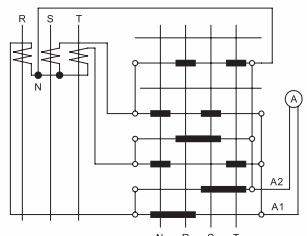
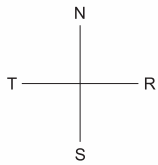

TVS33-□□
AS(3Ø3W 2CT)
VS(3Ø3W)

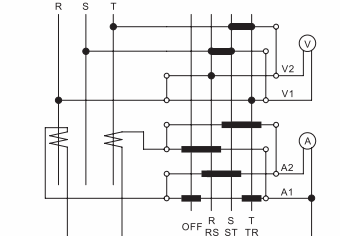
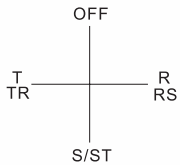

TVS334-□□
VS(3Ø3W)
VS(3Ø4W)

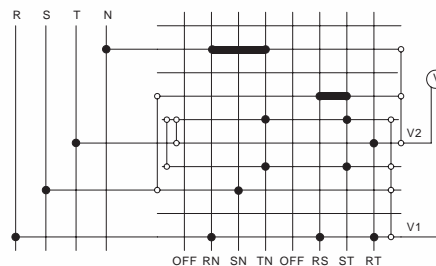
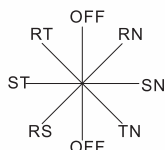

tend**VOLTMETER AND AMMETER
CAM SWITCH**

โวลต์มิเตอร์ และแอมมิเตอร์แคมสวิตช์

48x60 / 64x80

MODEL DESIGNATION

T AS33 - 713

① ② ③ ④

Designation	Signal	Description	Designation	Signal	Description
1.Control type	AS33	AS33 (3Ø3W)	2.Size	5	48*60
	AS34	AS34 (3Ø4W)		6	64*80
	VS33	VS33 (3Ø3W)	3.Capacity	1	10A
	VS34	VS34 (3Ø4W)		2	16A
	VS334	VS334 (3Ø3W) / VS34 (3Ø4W)		3	25A
	AV33	AV33 (3Ø3W) / AS34 (3Ø3W)	4.Nos.of	None	2CT
		3		3CT	

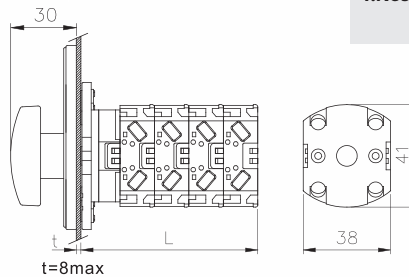
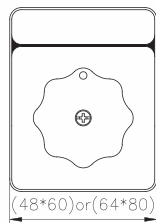
DIMENSIONS

Stack	L
One stack	32
Two stacks	47
Three stacks	62
Four stacks	77
Five stacks	92
Six stacks	107

PLATE, CONTACT AND WIRING DIAGRAM

TAS33-□□
AS(3Ø3W 2CT)

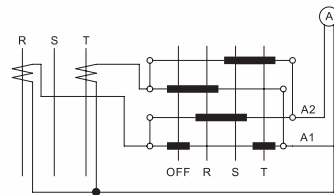
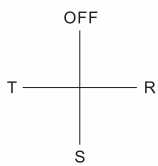

TVS33-□□
VS(3Ø3W)

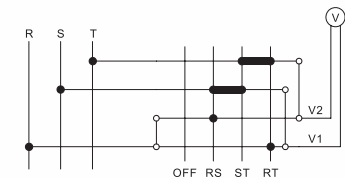
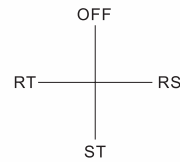

TAS33-□□3
AS(3Ø3W 3CT)

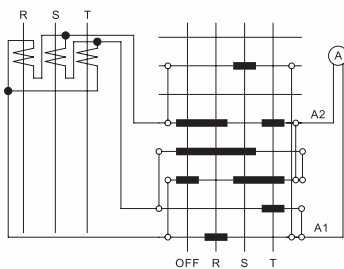
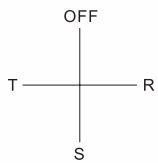

TVS34-□□
VS(3Ø4W)

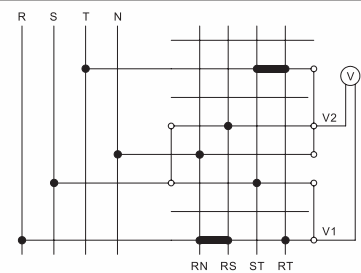
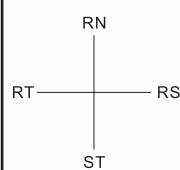

TAS34-□□3
AS(3Ø4W 3CT)

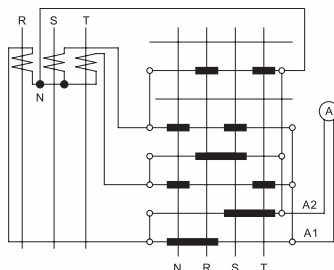
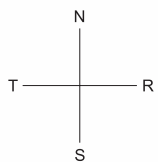

TVS33-□□
AS(3Ø3W 2CT)
VS(3Ø3W)

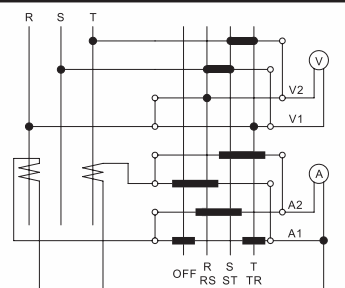
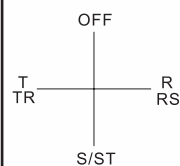

TVS334-□□
VS(3Ø3W)
VS(3Ø4W)

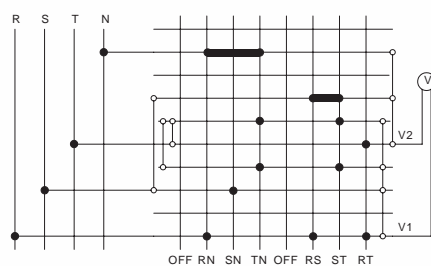
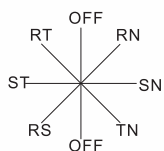

MODEL DESIGNATION

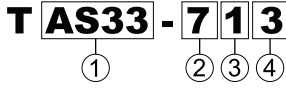

Designation	Signal	Description	Designation	Signal	Description
1. Control type	AS33	AS33(3Ø3W)	2. Size	4	48*48
	AS34	AS34(3Ø4W)		5	48*60
	VS33	VS33(3Ø3W)		6	64*64
	VS34	VS34(3Ø4W)		7	64*80
	VS334	VS33(3Ø3W)/VS34(3Ø4W)	3. Capacity	1	10A
	AV33	AV33(3Ø3W),AS33(3Ø3W)		2	16A
		3		25A	
			4. Nos.of	None	2CT
				3	3CT

DIMENSION

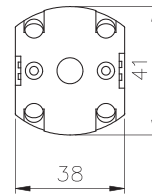
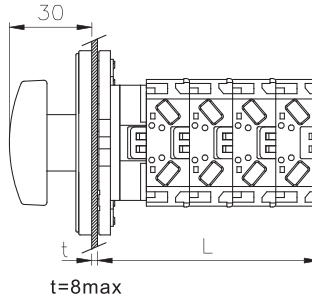
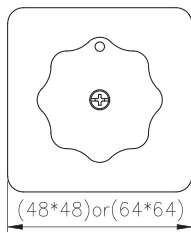

Stack	L
One Stack	32
Two Stacks	47
Three Stacks	62
Four Stacks	77
Five Stacks	92
Six Stacks	107

• All these series of switches are fitted with short handle.

• 2CT or 3CT can be used for TAS33 series.

รุ่นนิยม



หน้าปัดสี่เหลี่ยม ลูกบิดสีแดง (ซีล็คเตอร์โวลต์ แอมป์)

Item no.	Description		Contact blocks	Amp	Price with short handle
	Size	Plate			
TAS33-4R1S	496	Amp selector 48x48 mm (3Ø3W2CT)	2 Stacks	10A	390.-
TAS33-6R1S	496	Amp selector 64x64 mm (3Ø3W2CT)	2 Stacks	10A	390.-
TAS33A-4R1S	496	Amp selector 48x48 mm (3Ø3W3CT)	3 Stacks	10A	460.-
TAS33A-6R1S	496	Amp selector 64x64 mm (3Ø3W3CT)	3 Stacks	10A	460.-
TVS33-4R1S	494	Volt selector 48x48 mm (3Ø3W)	2 Stacks	10A	385.-
TVS33-6R1S	494	Volt selector 64x64 mm (3Ø3W)	2 Stacks	10A	385.-
TVS334A-4R1S	843	Volt selector 48x48 mm (3Ø3W & 3Ø4W)	3 Stacks	10A	460.-
TAS334A-6R1S	843	Volt selector 64x64 mm (3Ø3W & 3Ø4W)	3 Stacks	10A	460.-

รุ่นนิยม



Voltmeter / Ammeter cam switch (48x48 and 64x64)

หน้าปัดสี่เหลี่ยม ลูกบิดสีแดง (ซีล็คเตอร์โวลต์ แอมป์)

Item no.	Description		Contact blocks	Amp	Price with short handle
	Size	Plate			
TAS33-5R1S	496A	Amp selector 48x48 mm (3 Ø3W2CT)	2 Stacks	10A	415.-
TAS33-7R1S	496A	Amp selector 64x64 mm (3 Ø3W2CT)	2 Stacks	10A	415.-
TAS33A-5R1S	496A	Amp selector 48x48 mm (3 Ø3W3CT)	3 Stacks	10A	485.-
TAS33A-7R1S	496A	Amp selector 64x64 mm (3 Ø3W3CT)	3 Stacks	10A	485.-
TVS33-5R1S	494B	Volt selector 48x48 mm (3 Ø3W)	2 Stacks	10A	415.-
TVS33-7R1S	494B	Volt selector 64x64 mm (3 Ø3W)	2 Stacks	10A	415.-
TVS334A-5R1S	843B	Volt selector 48x48 mm (3 Ø3W & 3 Ø4W)	3 Stacks	10A	485.-
TAS334A-7R1S	843B	Volt selector 64x64 mm (3 Ø3W & 3 Ø4W)	3 Stacks	10A	485.-

* หากต้องการเปลี่ยนเป็น Long handle (ลูกบิดก้านยาว) หรือ Octagonal handle (ลูกบิดหัวกลม) สอบถามราคาเพิ่มเติมได้ที่พนักงานขายของบริษัท

** หากต้องการหน้าปัดสีขาว ลูกบิดสีดำสามารถแจ้งเปลี่ยนได้

tend VOLTmeter AND AMMETER CAM SWITCH

โวลต์มิเตอร์ และแอมมิเตอร์แคมสวิตช์

48x48 / 48x60 / 64x64 / 64x80

MODEL DESIGNATION

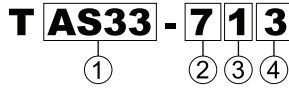

Designation	Signal	Description	Designation	Signal	Description
1. Control type	AS33	AS33(3Ø3W)	2. Size	4	48*48
	AS34	AS34(3Ø4W)		5	48*60
	VS33	VS33(3Ø3W)		6	64*64
	VS34	VS34(3Ø4W)		7	64*80
	VS334	VS33(3Ø3W)/VS34(3Ø4W)	3. Capacity	1	10A
	AV33	AV33(3Ø3W),AS33(3Ø3W)		2	16A
		3		25A	
4. Nos. of			None	2CT	
			3	3CT	

DIMENSION

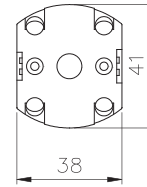
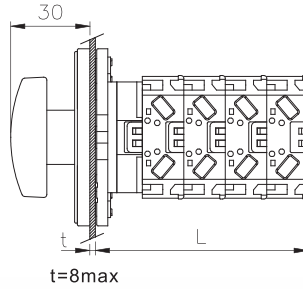
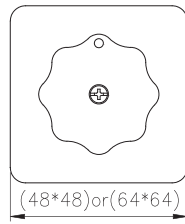

Stack	L
One Stack	32
Two Stacks	47
Three Stacks	62
Four Stacks	77
Five Stacks	92
Six Stacks	107

• All these series of switches are fitted with short handle.

• 2CT or 3CT can be used for TAS33 series.

Voltmeter / Ammeter cam switch (48x48 and 64x64)

หน้าปิดสี่เหลี่ยม ลูกบิดสี่แฉก (ซีล็คเตอร์โวลต์ แอมป์)



Item no.	Description		Contact blocks	Amp	Price with short handle
	Size	Plate			
TAS33-4R1S	496	Amp selector 48x48 mm (3Ø3W2CT)	2 stacks	10A	390.-
TAS33-6R1S	496	Amp selector 64x64 mm (3Ø3W2CT)	2 stacks	10A	390.-
TAS33A-4R1S	496	Amp selector 48x48 mm (3Ø3W3CT)	3 stacks	10A	460.-
TAS33A-6R1S	496	Amp selector 64x64 mm (3Ø3W3CT)	3 stacks	10A	460.-
TAS33-4R13S	496	Amp selector 48x48 mm (3Ø3W3CT)	4 stacks	10A	525.-
TAS33-6R13S	496	Amp selector 64x64 mm (3Ø3W3CT)	4 stacks	10A	525.-
TAS34A-4R1S	493	Amp selector 48x48 mm (3Ø4W3CT)	4 stacks	10A	525.-
TAS34-6R1S	493	Amp selector 64x64 mm (3Ø4W3CT)	4 stacks	10A	525.-
TVS33-4R1S	494	Volt selector 48x48 (3Ø3W)	2 stacks	10A	385.-
TVS33-6R1S	494	Volt selector 64x64 (3Ø3W)	2 stacks	10A	385.-
TVS334A-4R1S	843	Volt selector 48x48 (3Ø3W&3Ø4W)	3 stacks	10A	460.-
TVS334A-6R1S	843	Volt selector 64x64 (3Ø3W&3Ø4W)	3 stacks	10A	460.-
TVS334-4R1S	843	Volt selector 48x48 (3Ø3W&3Ø4W)	4 stacks	10A	635.-
TVS334-6R1S	843	Volt selector 64x64 (3Ø3W&3Ø4W)	4 stacks	10A	635.-
TVS34-4R1S	495	Volt selector 48x48 (3Ø4W)	4 stacks	10A	525.-
TVS34-6R1S	495	Volt selector 64x64 (3Ø4W)	4 stacks	10A	525.-
TAV33-4R1S	497	Amp selector 48x48 (3Ø3W 2CT) & Volt selector 48x48 (3Ø3W)	4 stacks	10A	525.-
TAV33-6R1S	497	Amp selector 64x64 (3Ø3W 2CT) & Volt selector 64x64 (3Ø3W)	4 stacks	10A	525.-

หมายเหตุ

TVS 334 และ TVS334A สามารถเลือกใช้ได้ทั้ง 3 Ø3W หรือ 3 Ø4W ในตัวเดียวกัน TAV33 สามารถใช้ได้ Amp selector (3 Ø3W2CT) และ Volt selector (3 Ø3W) ในตัวเดียวกัน

* หากต้องการเปลี่ยนเป็น Long handle (ลูกบิดก้านยาว) หรือ Octagonal handle (ลูกบิดหัวกลม)

สอบถามราคาเพิ่มเติมได้ที่พนักงานขายของบริษัท

** หากต้องการหน้าปิดสี่เหลี่ยม ลูกบิดสี่แฉกสามารถแจ้งเปลี่ยนได้

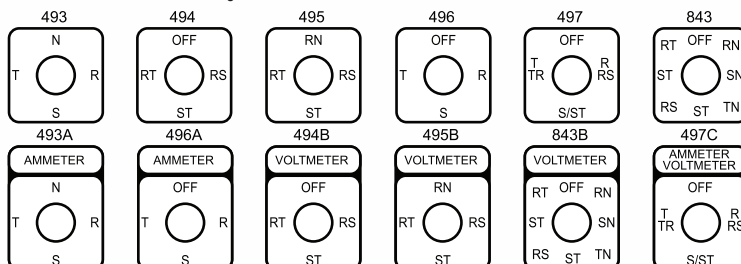

(ซีล็คเตอร์โวลต์ แอมป์)

Voltmeter / Ammeter cam switch (48x60 and 64x80)

หน้าปิดสีเหลือง
ลูกบิดสีแดง



Item no.	Description		Contact blocks	Amp	Price with short handle
	Size	Plate			
TAS33-5R1S	496A	Amp Selector 48x60 mm (3 Ø3W2CT)	2 stacks	10A	415.-
TAS33-7R1S	496A	Amp Selector 64x80 mm (3 Ø3W2CT)	2 stacks	10A	415.-
TAS33A-5R1S	496A	Amp Selector 48x60 mm (3 Ø3W2CT)	3 stacks	10A	485.-
TAS33A-7R1S	496A	Amp Selector 64x80 mm (3 Ø3W2CT)	3 stacks	10A	485.-
TAS33-5R13S	496A	Amp Selector 48x60 mm (3 Ø3W2CT)	4 stacks	10A	550.-
TAS33-7R13S	496A	Amp Selector 64x80 mm (3 Ø3W2CT)	4 stacks	10A	550.-
TAS34A-5R1S	493A	Amp Selector 48x60 mm (3 Ø3W2CT)	4 stacks	10A	550.-
TAS34-7R1S	493A	Amp Selector 64x80 mm (3 Ø3W2CT)	4 stacks	10A	550.-
TVS33-5R1S	494B	Volt Selector 48x60 mm (3 Ø3W)	2 stacks	10A	415.-
TVS33-7R1S	494B	Volt Selector 64x80 mm (3 Ø3W)	2 stacks	10A	415.-
TVS334A-5R1S	843B	Volt Selector 48x60 mm (3 Ø3W)	3 stacks	10A	485.-
TVS334A-7R1S	843B	Volt Selector 48x60 mm (3 Ø3W)	3 stacks	10A	485.-
TVS334-5R1S	843B	Volt Selector 48x60 mm (3 Ø3W)	4 stacks	10A	655.-
TVS334-7R1S	843B	Volt Selector 48x60 mm (3 Ø3W)	4 stacks	10A	655.-
TVS34-5R1S	495B	Volt Selector 48x60 mm (3 Ø3W)	4 stacks	10A	550.-
TVS34-7R1S	495B	Volt Selector 48x60 mm (3 Ø3W)	4 stacks	10A	550.-
TAV33-5R1S	497C	Amp Selector 48x60 (3 Ø3W2CT)& Volt Selector 48x60 (3 Ø3W)	4 stacks	10A	550.-
TAV33-7R1S	497C	Amp Selector 48x60 (3 Ø3W2CT)& Volt Selector 48x60 (3 Ø3W)	4 stacks	10A	550.-

หน้าปิดสีเหลือง
ลูกบิดสีแดง
(ซีล็คเตอร์โวลต์ แอมป์)



Voltmeter / Ammeter cam switch (48x48 and 64x64)

Item no.	Description		Contact blocks	Amp	Price with short handle
	Size	Plate			
TAS33-4R2S	496	Amp Selector 48x48 mm (3 Ø3W2CT)	2 stacks	16A	440.-
TAS33-6R2S	496	Amp Selector 64x64 mm (3 Ø3W2CT)	2 stacks	16A	440.-
TAS33A-4R2S	496	Amp Selector 48x48 mm (3 Ø3W2CT)	3 stacks	16A	535.-
TAS33A-6R2S	496	Amp Selector 64x64 mm (3 Ø3W2CT)	3 stacks	16A	535.-
TAS33-4R23S	496	Amp Selector 48x48 mm (3 Ø3W2CT)	4 stacks	16A	635.-
TAS33-6R23S	496	Amp Selector 64x64 mm (3 Ø3W2CT)	4 stacks	16A	635.-
TAS34A-4R2S	493	Amp Selector 48x48 mm (3 Ø3W2CT)	4 stacks	16A	635.-
TAS34-6R2S	493	Amp Selector 64x64 mm (3 Ø3W2CT)	4 stacks	16A	635.-
TVS33-4R2S	494	Volt Selector 48x48 mm (3 Ø3W)	2 stacks	16A	440.-
TVS33-6R2S	494	Volt Selector 64x64 mm (3 Ø3W)	2 stacks	16A	440.-
TVS334A-4R2S	843	Volt Selector 48x48 mm (3 Ø3W)	3 stacks	16A	535.-
TVS334A-6R2S	843	Volt Selector 48x64 mm (3 Ø3W)	3 stacks	16A	535.-
TVS334-4R2S	843	Volt Selector 48x48 mm (3 Ø3W)	4 stacks	16A	760.-
TVS334-6R2S	843	Volt Selector 48x64 mm (3 Ø3W)	4 stacks	16A	760.-
TVS34-4R2S	495	Volt Selector 48x480 mm (3 Ø3W)	4 stacks	16A	635.-
TVS34-6R2S	495	Volt Selector 48x64 mm (3 Ø3W)	4 stacks	16A	635.-
TAV33-4R2S	497	Amp Selector 48x48 mm(3 Ø3W2CT)& Volt Selector 48x48 mm(3 Ø3W)	4 stacks	16A	635.-
TAV33-6R2S	497	Amp Selector 48x64 mm(3 Ø3W2CT)& Volt Selector 48x64 mm(3 Ø3W)	4 stacks	16A	635.-

หมายเหตุ

TVS 334 และ TVS334A สามารถเลือกใช้ได้ทั้ง 3 Ø3W หรือ 3 Ø4W ในตัวเดียวกัน TAV33 สามารถใช้ได้ Amp selector (3 Ø3W2CT) และ Volt selector (3 Ø3W) ในตัวเดียวกัน

* หากต้องการเปลี่ยนเป็น Long handle (ลูกบิดก้านยาว) หรือ Octagonal handle (ลูกบิดหัวกลม)

สอบถามราคาเพิ่มเติมได้ที่พนักงานขายของบริษัท

** หากต้องการหน้าปิดสีขาว ลูกบิดสีดำสามารถแจ้งเปลี่ยนได้

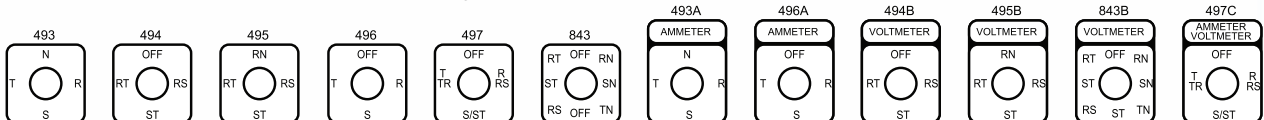

tend VOLTMETER AND AMMETER CAM SWITCH

โวลต์มิเตอร์ และแอมมิเตอร์แคมสวิตช์

48x48 / 48x60 / 64x64 / 64x80

(ซีเล็คเตอร์โวลต์ แอมป์)

Voltmeter / Ammeter cam switch (48x60 and 64x80)

หน้าปิดสีเหลือง
ลูกบิดสีแดง



Item no.	Description		Contact blocks	Amp	Price with short handle
	Size	Plate			
TAS33-5R2S	496A	Amp Selector 48x60 mm (3 Ø3W2CT)	2 stacks	16A	470.-
TAS33-7R2S	496A	Amp Selector 64x80 mm (3 Ø3W2CT)	2 stacks	16A	470.-
TAS33A-5R2S	496A	Amp Selector 48x60 mm (3 Ø3W2CT)	3 stacks	16A	565.-
TAS33A-7R2S	496A	Amp Selector 64x80 mm (3 Ø3W2CT)	3 stacks	16A	565.-
TAS33-5R23S	496A	Amp Selector 48x60 mm (3 Ø3W3CT)	4 stacks	16A	655.-
TAS33-7R23S	496A	Amp Selector 64x80 mm (3 Ø3W3CT)	4 stacks	16A	655.-
TAS34A-5R2S	493A	Amp Selector 48x60 mm (3 Ø3W3CT)	4 stacks	16A	655.-
TAS34-7R2S	493A	Amp Selector 64x80 mm (3 Ø3W3CT)	4 stacks	16A	655.-
TVS33-5R2S	494B	Volt Selector 48x60 mm (3 Ø3W)	2 stacks	16A	470.-
TVS33-7R2S	494B	Volt Selector 64x80 mm (3 Ø3W)	2 stacks	16A	470.-
TVS334A-5R2S	843B	Volt Selector 48x60 mm (3 Ø3W&3 Ø4W)	3 stacks	16A	565.-
TVS334A-7R2S	843B	Volt Selector 48x60 mm (3 Ø3W&3 Ø4W)	3 stacks	16A	565.-
TVS334-5R2S	843B	Volt Selector 48x60 mm (3 Ø3W&3 Ø4W)	4 stacks	16A	790.-
TVS334-7R2S	843B	Volt Selector 48x60 mm (3 Ø3W&3 Ø4W)	4 stacks	16A	790.-
TVS34-5R2S	495B	Volt Selector 48x60 mm (3 Ø4W)	4 stacks	16A	655.-
TVS34-7R2S	495B	Volt Selector 48x60 mm (3 Ø4W)	4 stacks	16A	655.-
TAV33-5R2S	497C	Amp Selector 48x60 mm (3 Ø3W2CT)& Volt Selector 48x60 mm (3 Ø3W)	4 stacks	16A	655.-
TAV33-7R2S	497C	Amp Selector 48x60 mm (3 Ø3W2CT)& Volt Selector 48x60 mm (3 Ø3W)	4 stacks	16A	655.-

Voltmeter / Ammeter cam switch (48x48 and 64x64)

หน้าปิดสีเหลือง
ลูกบิดสีแดง
(ซีเล็คเตอร์โวลต์ แอมป์)



Item no.	Description		Contact blocks	Amp	Price with short handle
	Size	Plate			
TAS33-4R3S	496	Amp Selector 48x48 mm (3 Ø3W2CT)	2 stacks	25A	515.-
TAS33-6R3S	496	Amp Selector 64x64 mm (3 Ø3W2CT)	2 stacks	25A	515.-
TAS33A-4R3S	496	Amp Selector 48x48 mm (3 Ø3W2CT)	3 stacks	25A	620.-
TAS33A-6R3S	496	Amp Selector 64x64 mm (3 Ø3W2CT)	3 stacks	25A	620.-
TAS33-4R33S	496	Amp Selector 48x48 mm (3 Ø3W3CT)	4 stacks	25A	730.-
TAS33-6R33S	496	Amp Selector 64x64 mm (3 Ø3W3CT)	4 stacks	25A	730.-
TAS34A-4R3S	493	Amp Selector 48x48 mm (3 Ø3W3CT)	4 stacks	25A	730.-
TAS34-6R3S	493	Amp Selector 64x64 mm (3 Ø3W3CT)	4 stacks	25A	730.-
TVS33-4R3S	494	Volt Selector 48x48 mm (3 Ø3W)	2 stacks	25A	515.-
TVS33-6R3S	494	Volt Selector 64x64 mm (3 Ø3W)	2 stacks	25A	515.-
TVS334A-4R3S	843	Volt Selector 48x48 mm (3 Ø3W&3 Ø4W)	3 stacks	25A	620.-
TVS334A-6R3S	843	Volt Selector 64x64 mm (3 Ø3W&3 Ø4W)	3 stacks	25A	620.-
TVS334-4R3S	843	Volt Selector 48x48 mm (3 Ø3W&3 Ø4W)	4 stacks	25A	870.-
TVS334-6R3S	843	Volt Selector 64x64 mm (3 Ø3W&3 Ø4W)	4 stacks	25A	870.-
TVS34-4R3S	495	Volt Selector 48x48 mm (3 Ø4W)	4 stacks	25A	730.-
TVS34-6R3S	495	Volt Selector 64x64 mm (3 Ø4W)	4 stacks	25A	730.-
TAV33-4R3S	497	Amp Selector 48x48 mm (3 Ø3W2CT)& Volt Selector 48x48 mm (3 Ø3W)	4 stacks	25A	730.-
TAV33-6R3S	497	Amp Selector 64x64 mm (3 Ø3W2CT)& Volt Selector 64x64 mm (3 Ø3W)	4 stacks	25A	730.-

หมายเหตุ

TVS 334 และ TVS334A สามารถเลือกใช้ได้ทั้ง 3 Ø3W หรือ 3 Ø4W ในตัวเดียวกัน TAV33 สามารถใช้ได้ Amp selector (3 Ø3W2CT) และ Volt selector (3 Ø3W) ในตัวเดียวกัน

* หากต้องการเปลี่ยนเป็น Long handle (ลูกบิดก้านยาว) หรือ Octagonal handle (ลูกบิดหัวกลม)

สอบถามราคาเพิ่มเติมได้ที่พนักงานขายของบริษัท

** หากต้องการหน้าปิดสีขาว ลูกบิดสีดำสามารถแจ้งเปลี่ยนได้

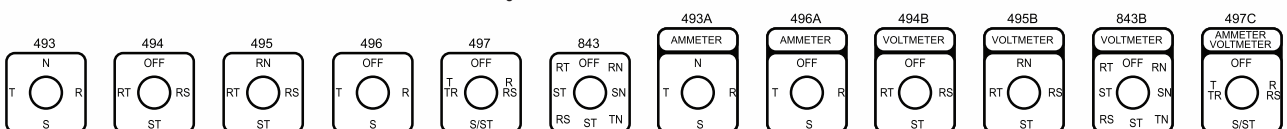

*ขอสงวนสิทธิ์ในการเปลี่ยนแปลงราคา



VOLTMETER AND AMMETER CAM SWITCH

โวลต์มิเตอร์ และแอมมิเตอร์แคมสวิตช์

48x48 / 48x60 / 64x64 / 64x80

หน้าปิดสี่เหลี่ยม
ลูกบิดสี่แฉก

(ซีล็คเตอร์โวลต์ แอมป์)

Voltmeter / Ammeter cam switch (48x60 and 64x80)



Item no.		Description	Contact blocks	Amp	Price with short handle
Size	Plate				
TAS33-5R3S	496A	Amp selector 48x60 mm (3 Ø3W2CT)	2 Stacks	25A	535.-
TAS33-7R3S	496A	Amp selector 64x80 mm (3 Ø3W2CT)	2 Stacks	25A	535.-
TAS33A-5R3S	496A	Amp selector 48x60 mm (3 Ø3W2CT)	3 Stacks	25A	645.-
TAS33A-7R3S	496A	Amp selector 64x80 mm (3 Ø3W2CT)	3 Stacks	25A	645.-
TAS33-5R33S	496A	Amp selector 48x60 mm (3 Ø3W2CT)	4 Stacks	25A	750.-
TAS33-7R33S	496A	Amp selector 64x80 mm (3 Ø3W2CT)	4 Stacks	25A	750.-
TAS34-5R3S	493A	Amp selector 48x60 mm (3 Ø3W2CT)	4 Stacks	25A	750.-
TAS34-7R3S	493A	Amp selector 64x80 mm (3 Ø3W2CT)	4 Stacks	25A	750.-
TVS33-5R3S	494B	Volt selector 48x60 (3 Ø3W)	2 Stacks	25A	535.-
TVS33-7R3S	494B	Volt selector 64x80 (3 Ø3W)	2 Stacks	25A	535.-
TVS334A-5R3S	843B	Volt selector 48x60 (3 Ø3W&3 Ø4W)	3 Stacks	25A	645.-
TVS334A-7R3S	843B	Volt selector 48x60 (3 Ø3W&3 Ø4W)	3 Stacks	25A	645.-
TVS334-5R3S	843B	Volt selector 64x80 (3 Ø3W&3 Ø4W)	4 Stacks	25A	900.-
TVS334-7R3S	843B	Volt selector 64x80 (3 Ø3W&3 Ø4W)	4 Stacks	25A	900.-
TVS34A-5R3S	495B	Volt selector 48x60 (3 Ø4W)	4 Stacks	25A	750.-
TVS34A-7R3S	495B	Volt selector 64x80 (3 Ø4W)	4 Stacks	25A	750.-
TAV33-5R3S	497C	Amp selector 48x60 (3 Ø3W2CT)& Volt selector 48x60 (3 Ø3W)	4 Stacks	25A	750.-
TAV33-7R3S	497C	Amp selector 64x80 (3 Ø3W2CT)& Volt selector 64x80 (3 Ø3W)	4 Stacks	25A	750.-

หมายเหตุ

TVS 334 และ TVS334A สามารถเลือกใช้ได้ทั้ง 3 Ø3W หรือ 3 Ø4W ในตัวเดียวกัน TAV33 สามารถใช้ได้ Amp selector (3 Ø3W2CT) และ Volt selector (3 Ø3W) ในตัวเดียวกัน

* หากต้องการเปลี่ยนเป็น Long handle (ลูกบิดก้านยาว) หรือ Octagonal handle (ลูกบิดหัวกลม)

สอบถามราคาเพิ่มเติมได้ที่พนักงานขายของบริษัท

** หากต้องการหน้าปิดสีขาว ลูกบิดสีดำสามารถแจ้งเปลี่ยนได้

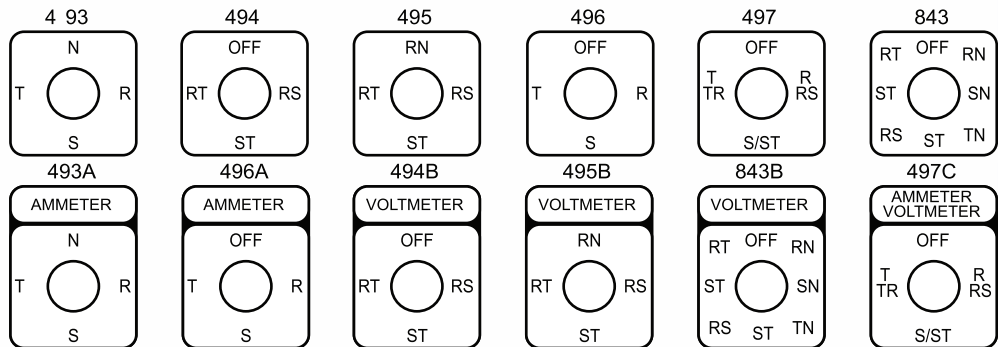

725.-

VOLT SELECTOR SWITCH

TYPE TVS-33 3 3W-VS@

TYPE TVS-34 3 4W-VS@

AMP SELECTOR SWITCH

TYPE TAS-33 3 3W-AS@

TYPE TAS-34 3 4W-AS@

